

0185417U01	Options X182AA (132–146 MHz)
0185417U02	X182AB (144–160 MHz)
0185417U03	X182AJ (158–174 MHz)

Note: This duplexer is identical to the RFS/Celwave PD5042-1-50

1 DESCRIPTION

Options 182AA/AB/AJ provide band–dependent duplexer modules for use with *Quantar* VHF stations. This section provides a general description, identification of adjustments and inputs/outputs, performance specifications, and a typical mounting location detail. While the duplexer module is considered non–repairable, tuning screws are provided for field tuning should replacement become necessary due to module failure, or if retuning is necessary due to a change in operating channels. A single channel field tuning procedure is provided in this section.

General Description

The duplexer module (shown in Figure 1) allows a transmit and receive channel pair to share a common TX/RX antenna. Each duplexer module consists of six resonant cavities (three for transmit and three for receive) contained in a temperature–compensated copper enclosure designed to mount in a standard EIA 19" equipment rack.

Each set of three cavities is designed and tuned to pass the respective transmit or receive channel frequency (or bandwidths) while providing maximum TX noise suppression at the RX frequency and maximum RX isolation at the TX frequency.

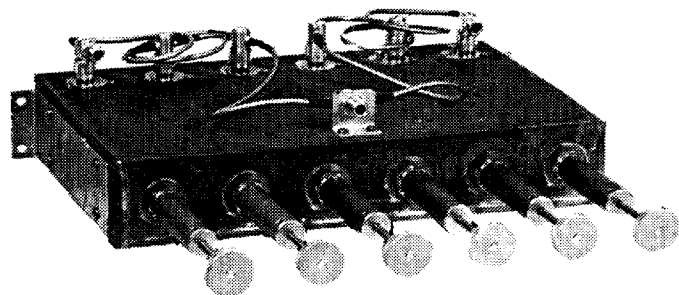

Figure 1. Typical Duplexer Module

2 ADJUSTMENTS AND INPUTS/OUTPUTS

Figure 2 shows the location of the adjustment screws and input and output rf connectors for the duplexer module.

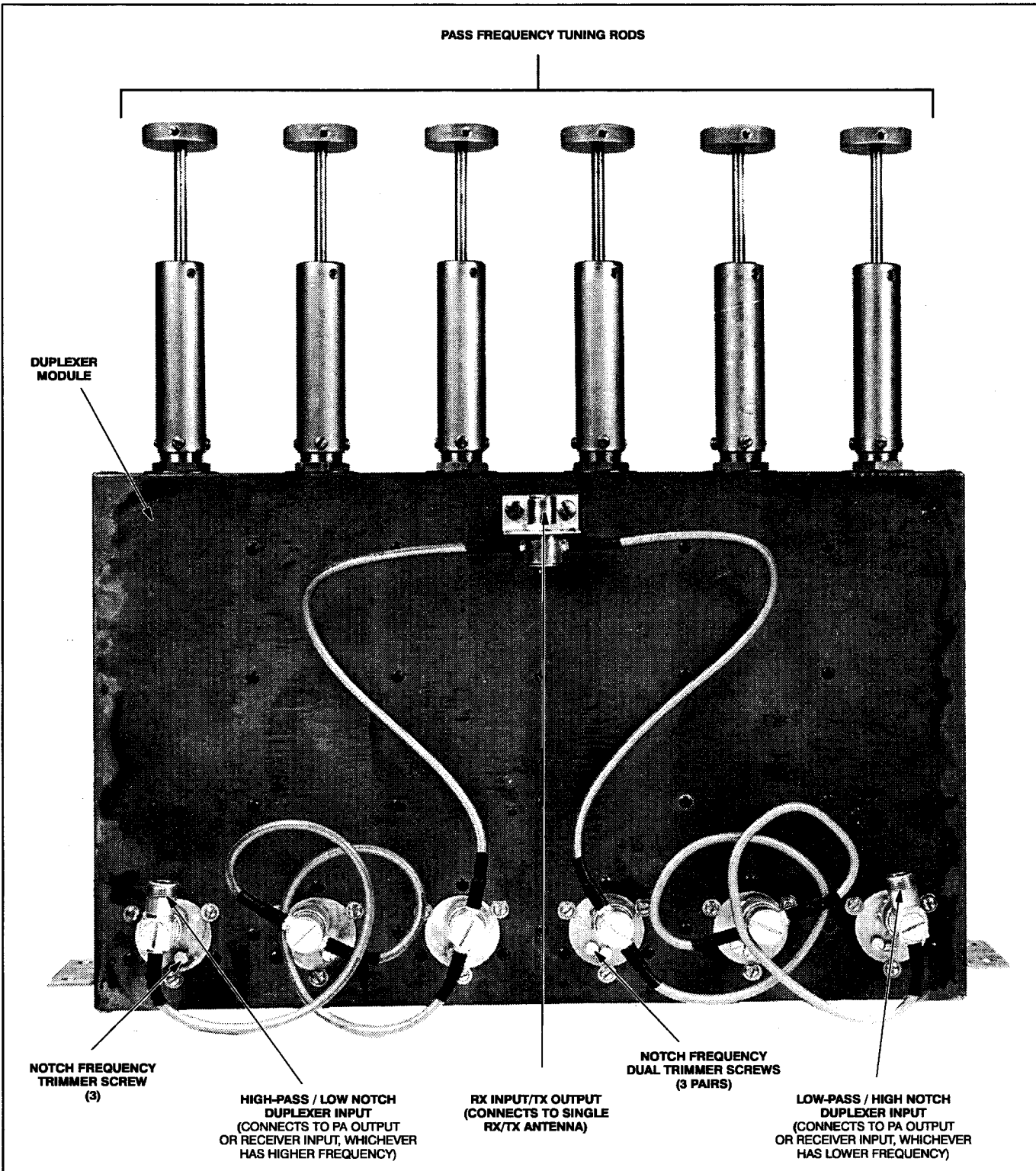

Figure 2. Quantar VHF Duplexer Module Adjustment Screws and Input/Output Connections

3 PERFORMANCE SPECIFICATIONS

Table 1 shows the electrical performance specifications for the duplexer module.

Performance Specifications

Table 1. Duplexer Performance Specifications (Options X182AA/AB/AJ)

Parameter	Specification	
Operating Frequency Model X182AA Model X182AB Model X182AJ	132–146 MHz 144–160 MHz 158–174 MHz	
Insertion Loss (Transmitter to Antenna)	1.3 dB max	
Insertion Loss (Antenna to Receiver)	1.3 dB max	
Frequency Bandwidth vs Frequency Separation	Tx-to-RX Spacing	Bandwidth (maximum)
	1.5 MHz	200 kHz
	2.5 MHz	600 kHz
	3.5 MHz	800 kHz
4.5 MHz and above	1000 kHz	
TX Noise Suppression at RX Freq.	75 dB min	
RX Isolation at TX Freq.	75 dB min	
Frequency Separation (Min.)	1.5 MHz	
Return Loss	14 dB minimum	
Maximum Input Power	150 W	
Temperature Range	–30°C to +60°C	
Size	3" (H) x 21.5" (D) x 17" (W) EIA Rack Mountable	
Weight	22 lbs.	
Terminations	Female N-Type	
Input and Output Impedance	50 Ohms	

SPECIFICATIONS SUBJECT TO CHANGE WITHOUT NOTICE

4 TYPICAL MOUNTING CONFIGURATION

The duplexer module is typically mounted in the same rack or cabinet as the station and peripheral tray (if equipped). Figure 3 shows front and rear views of a typical repeater configuration in which a station, triple circulator option, and duplexer option are installed in a single cabinet. Also shown is a simplified interconnect diagram showing the receiver and transmitter paths to a single RX/TX antenna.

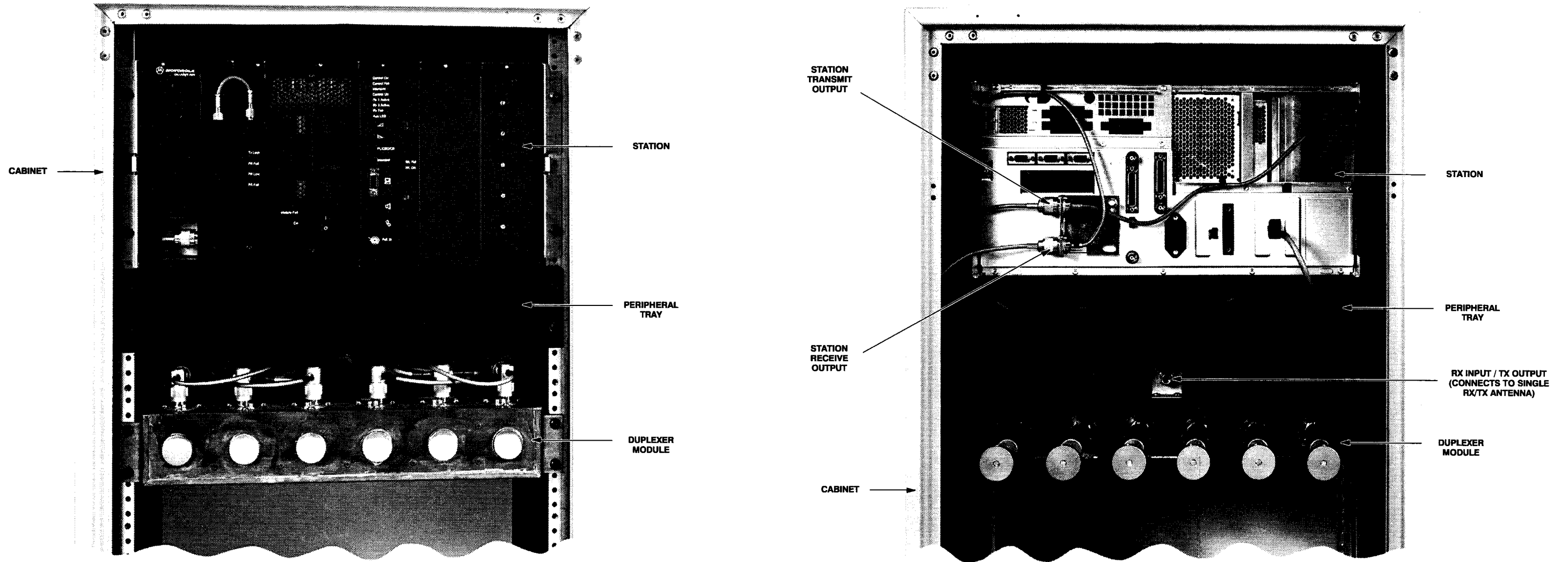

FRONT VIEW

REAR VIEW

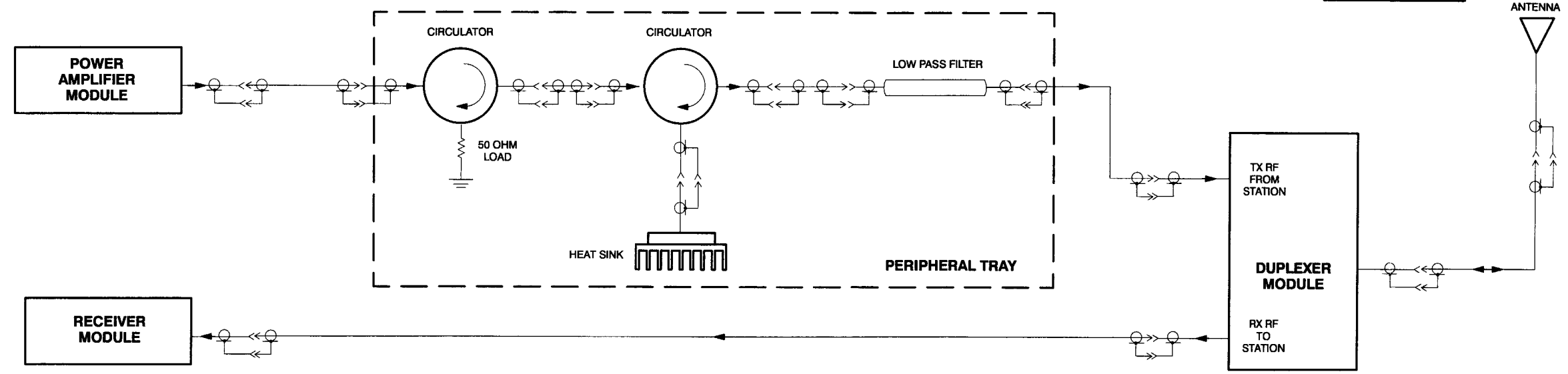

Figure 3. Typical Duplexer Mounting Configuration and Interconnect Diagram

5 FIELD TUNING PROCEDURE

Duplexer modules shipped with stations are tuned at the factory. If a duplexer must be replaced in the field, the unit must be installed and tuned specifically to the transmit and receive frequency pair for the particular station.

Field Tuning Overview

Note: This tuning procedure is valid for channels with a bandwidth of 200 kHz or less. If bandwidth is more than 200 kHz, the duplexer must be tuned by the service depot.

The duplexer module is comprised of three low-pass/high-notch cavities and three high-pass/low-notch cavities. Each set of three cavities provides bandpass filtering for either the transmit rf signal or the receive rf signal. In general, the duplexer must be tuned so that the transmit cavity set passes the transmit signal and rejects the receive signal; concurrently, the receive cavity set must be tuned to pass the receive signal and reject the transmit signal.

Tuning is performed by injecting rf signals and making tuning adjustments (using the tuning rods and trimmer screws) while monitoring for maximum or minimum readings on the rf millivoltmeter. Field tuning the duplexer module requires the following general adjustments:

- Tune high-pass/low-notch cavities for maximum pass and reject response
- Tune low-pass/high-notch cavities for maximum pass and reject response
- Check high-pass/low-notch and low-pass/high-notch cavities for insertion loss
- Check high-pass/low-notch and low-pass/high-notch cavities for isolation

Required Test Equipment

Field tuning of the duplexer module requires the following test equipment:

- Motorola R2001 Communications Analyzer (or equivalent)
- RF Millivoltmeter (Boonton 92E or equivalent)
- RF Signal Generator (HP8565 or equivalent)
- 50Ω N-type terminator
- Male-to-Females N-Type "T" connector (UG-107B/U or equiv.)
- Slotted screwdriver
- 3/32" allen wrench
- Tuning tool (thin blade)
- N-to-N bullet connector (UG29A/U or equivalent)
- N-to-BNC Adapter (UG349A/U)
- N-to-N Connector (UG57B/U)

Setting Up for Tuning Duplexer

VHF

Perform the preliminary tasks shown in Figure 4 to prepare for tuning the duplexer module.

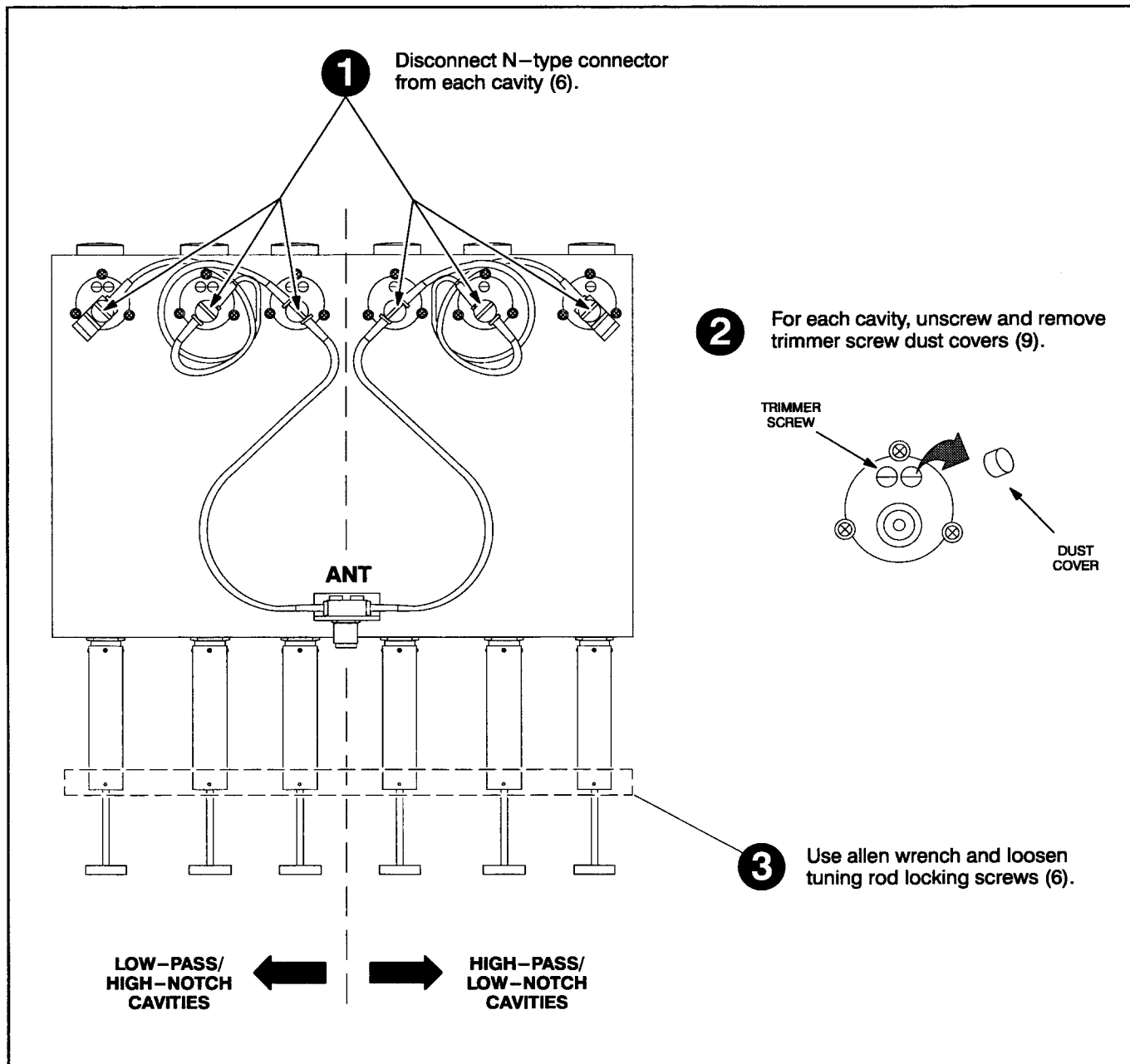

Figure 4. Preliminary Tasks Prior to Tuning Duplexer

Duplexer Tuning Procedure

The duplexer field tuning procedures are provided in Figure 5. The procedures are most easily performed with the duplexer module removed from the station rack or cabinet. Be sure to make note of the transmit and receive frequencies for the particular station before beginning.

If the duplexer module is tuned according to instructions and does not meet specifications for return loss, insertion loss, and/or isolation, you must return the duplexer for repair.

1 TUNING LOW PASS RESONATORS

- 1 Set up test equipment as shown.
- 2 Push or pull tuning rod for cavity #1 to obtain a **PEAK** reading on the millivoltmeter.
- 3 Use allen wrench and tighten locking screw.
- 4 Repeat steps 2 & 3 for cavities 2 and 3.

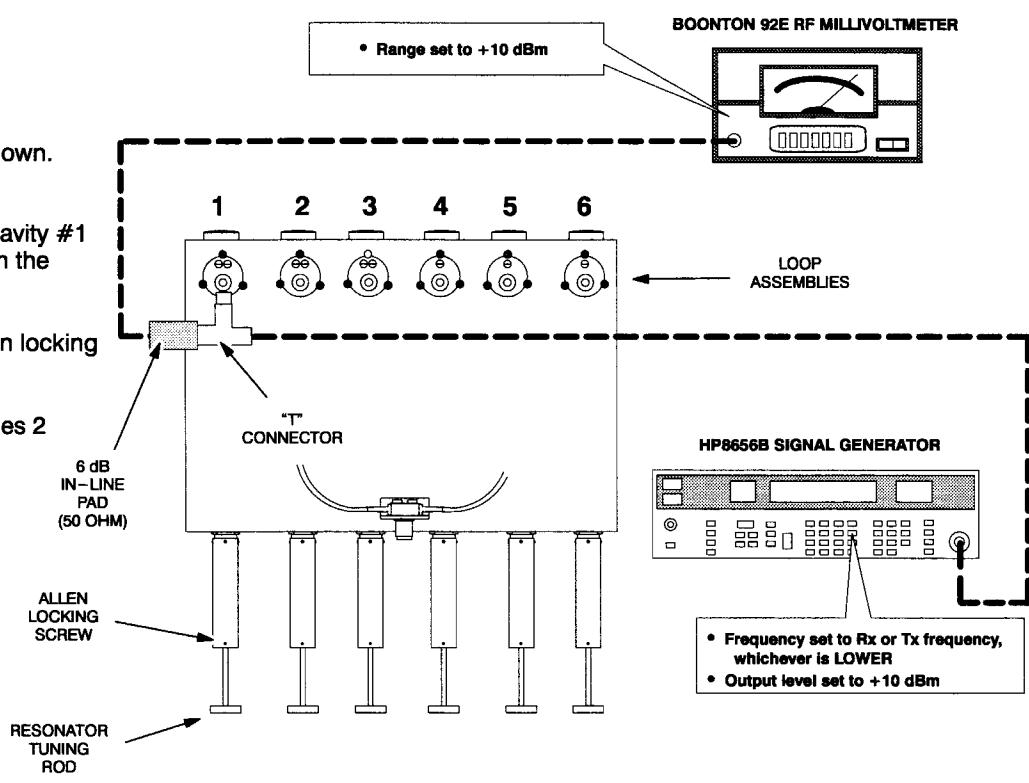

3 TUNING HIGH NOTCH LOOP ASSEMBLIES

- 1 Set up test equipment as shown.
- 2 Use tuning tool to adjust trimmer screws for cavity #1 to obtain **minimum** reading on millivoltmeter. (Adjust trimmer screws equally to obtain minimum. Reduce the range on the millivoltmeter as necessary to reach true minimum reading.)
- 3 Repeat steps 1 and 2 for cavities 2 and 3.

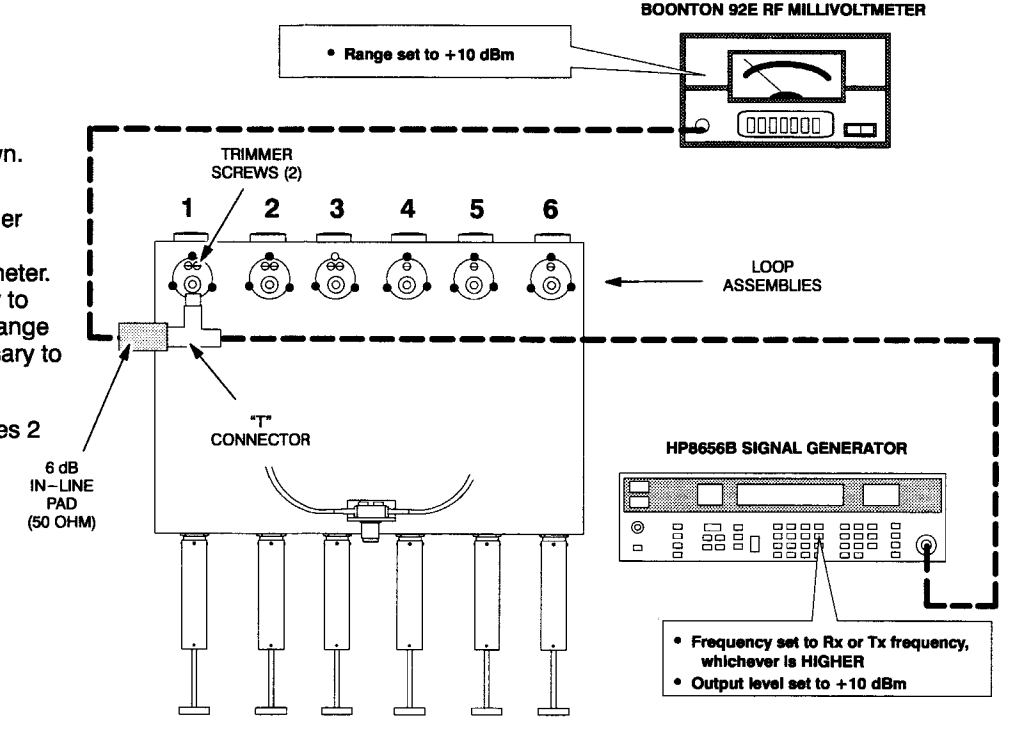

2 TUNING HIGH PASS RESONATORS

- 1 Set up test equipment as shown.
- 2 Push or pull tuning rod for cavity #4 to obtain a **PEAK** reading on the millivoltmeter.
- 3 Use allen wrench and tighten locking screw.
- 4 Repeat steps 2 & 3 for cavities 5 and 6.

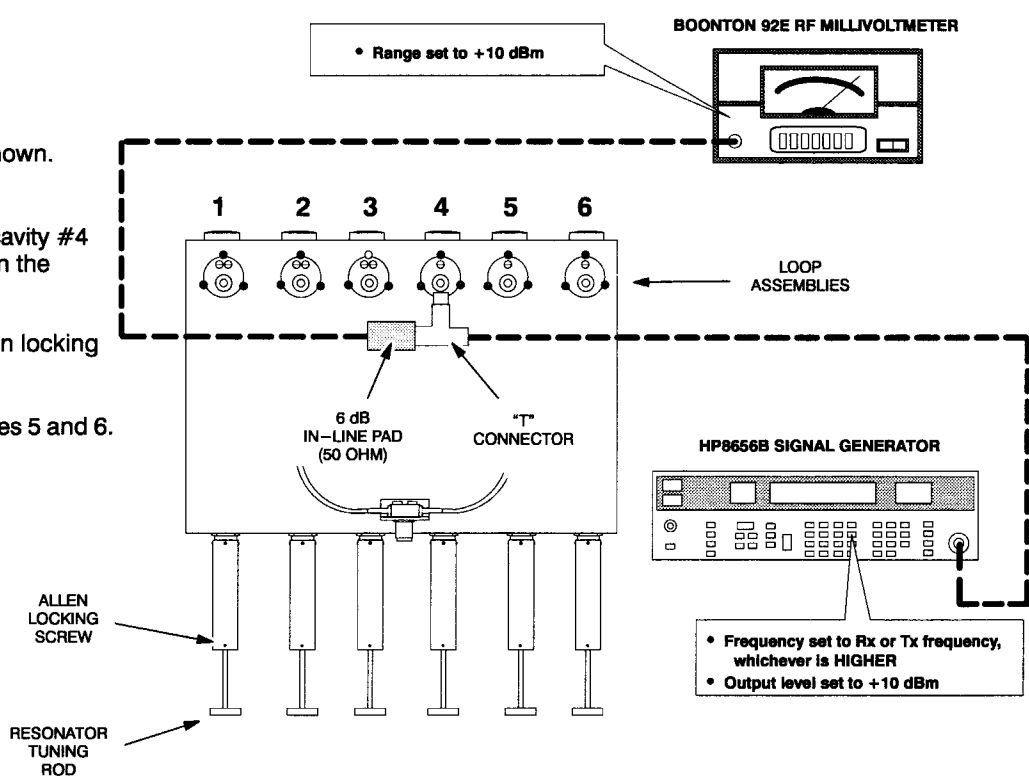

4 TUNING LOW NOTCH LOOP ASSEMBLIES

- 1 Set up test equipment as shown.
- 2 Use tuning tool to adjust trimmer screw for cavity #4 to obtain **minimum** reading on millivoltmeter. (Adjust trimmer screw to obtain minimum. Reduce the range on the millivoltmeter as necessary to reach true minimum reading.)
- 3 Repeat steps 1 and 2 for cavities 5 and 6.

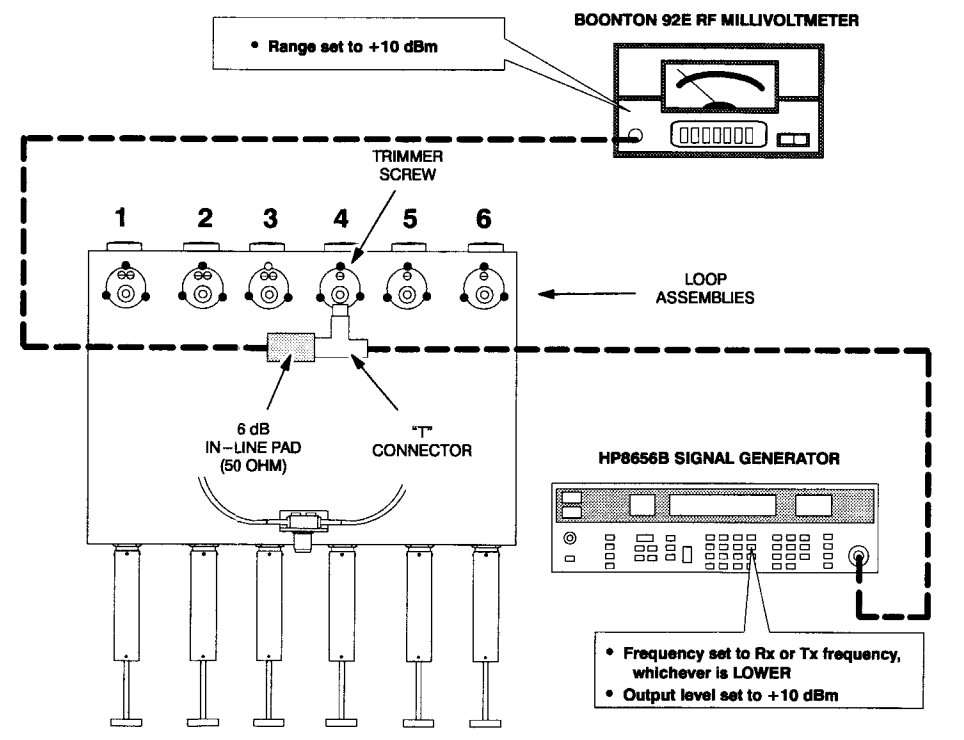
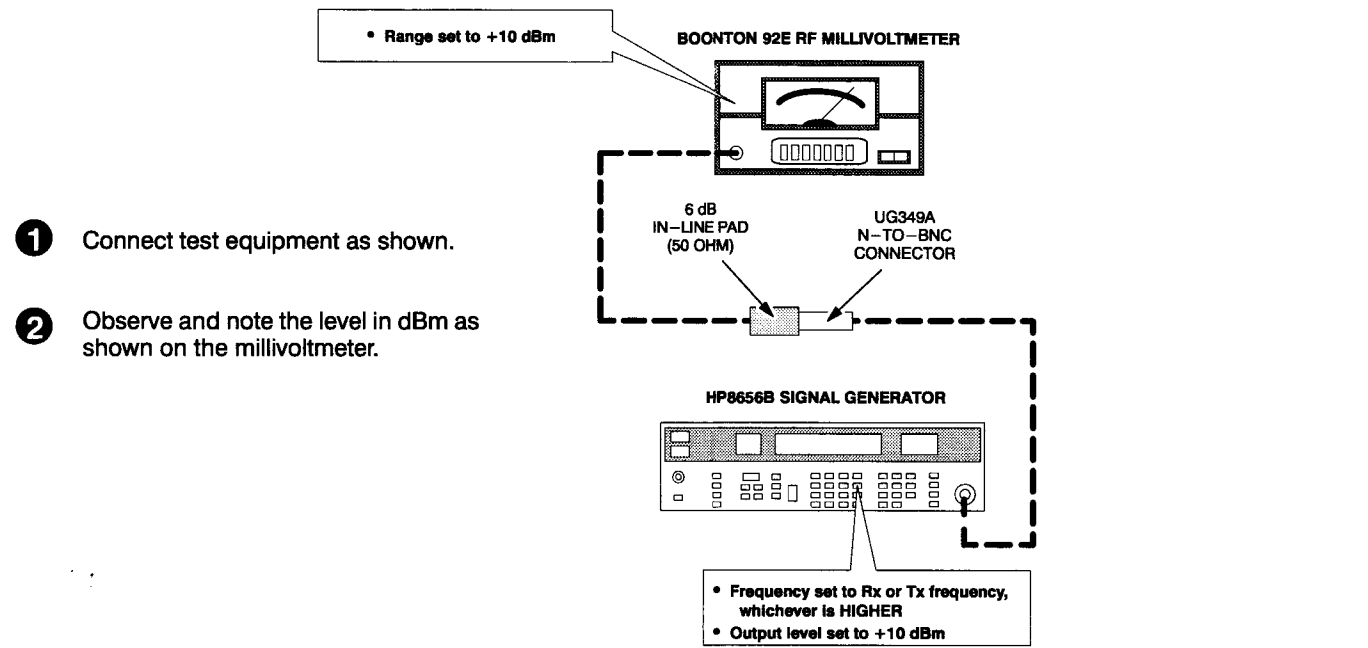

Figure 5. Quantar VHF Duplexer Field Tuning Procedure (Sheet 1 of 3)

5 VERIFYING INSERTION LOSS



- 1 Connect test equipment as shown.
- 2 Observe and note the level in dBm as shown on the millivoltmeter.

- 3 Connect the duplexer cable assembly and test equipment to the duplexer as shown.
- 4 Observe and note the level in dBm as shown on the millivoltmeter.
- 5 Subtract the absolute number noted in Step 2 from the number noted in Step 4. The difference should be less than 1.3 dB to meet specification for Insertion Loss.
- 6 Repeat Steps 1–5 for Low-Pass/High-Notch cavities with the following exceptions:

- 1) Set Frequency Generator for Rx or Tx frequency, whichever is **LOWER**
- 2) Connect Signal Generator to Low Pass duplexer input (cavity #1)
- 3) Connect terminator to cavity #6.

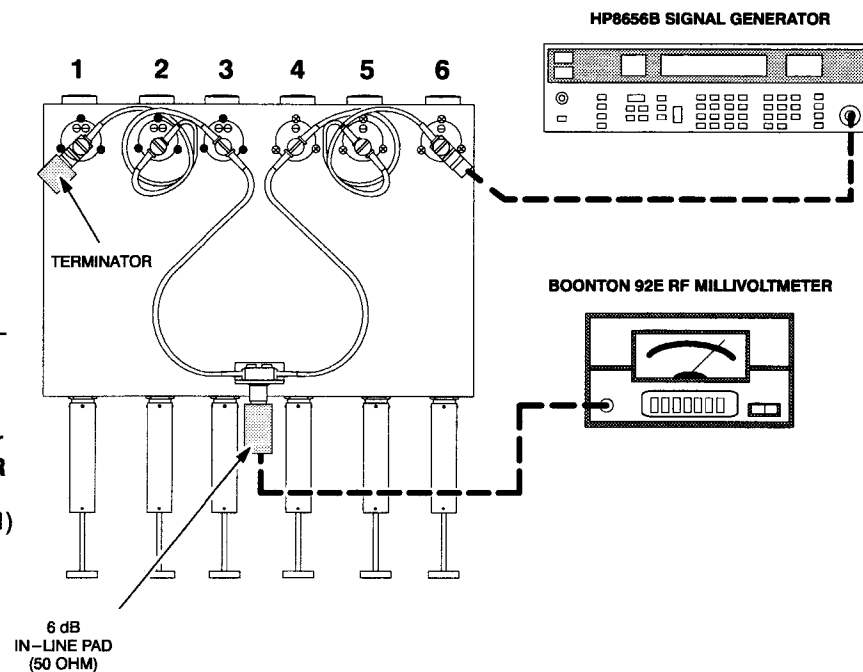

6 VERIFYING ISOLATION

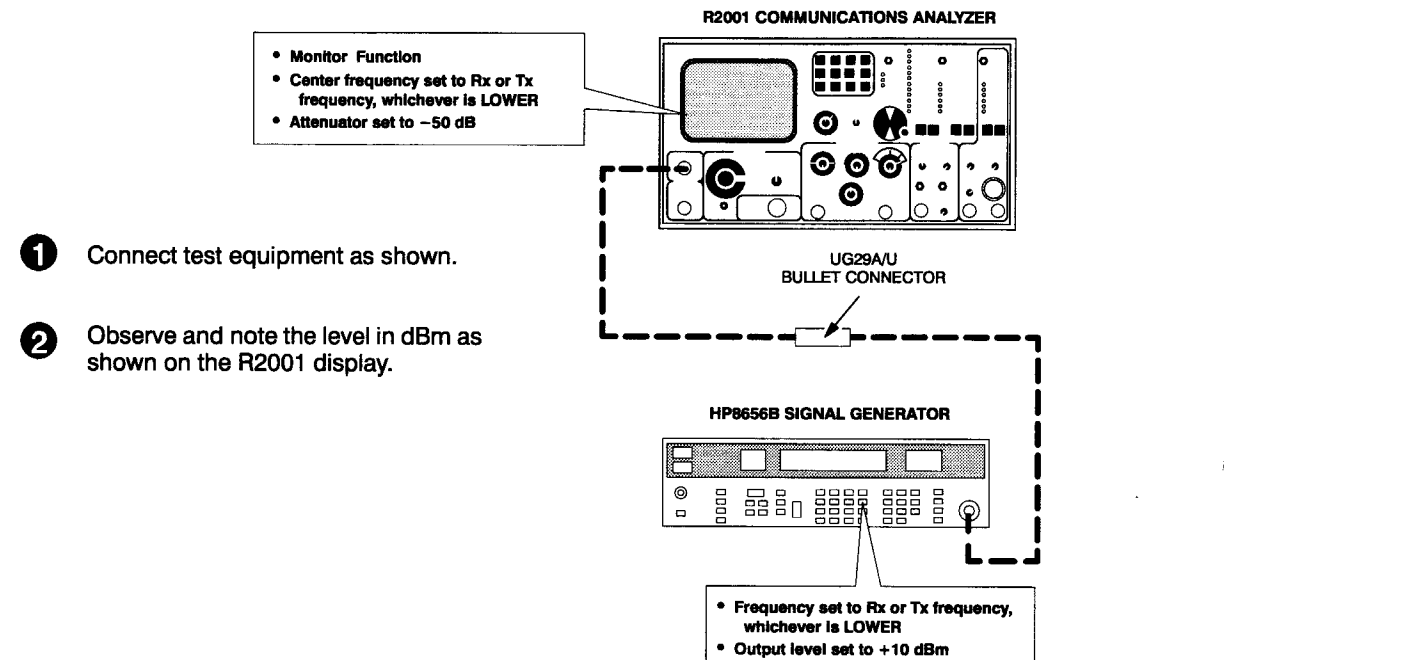

- 1 Connect test equipment as shown.
- 2 Observe and note the level in dBm as shown on the R2001 display.

- 3 Connect the test equipment to the duplexer as shown.
- 4 Observe and note the level in dBm as shown on the R2001 display. (If no number is displayed, consider isolation to be greater than 105 dB, which exceeds the specification.)
- 5 Subtract the absolute number noted in Step 4 from the number noted in Step 2. The difference should be higher than 75 dB to meet specification for Isolation.
- 6 Repeat Steps 1–5 for Low-Pass/High-Notch cavities with the following exceptions:

- 1) Set Frequency Generator and R2001 for Rx or Tx frequency, whichever is **HIGHER**
- 2) Connect Signal Generator to Low Pass duplexer input (cavity #1)
- 3) Connect terminator to cavity #6.

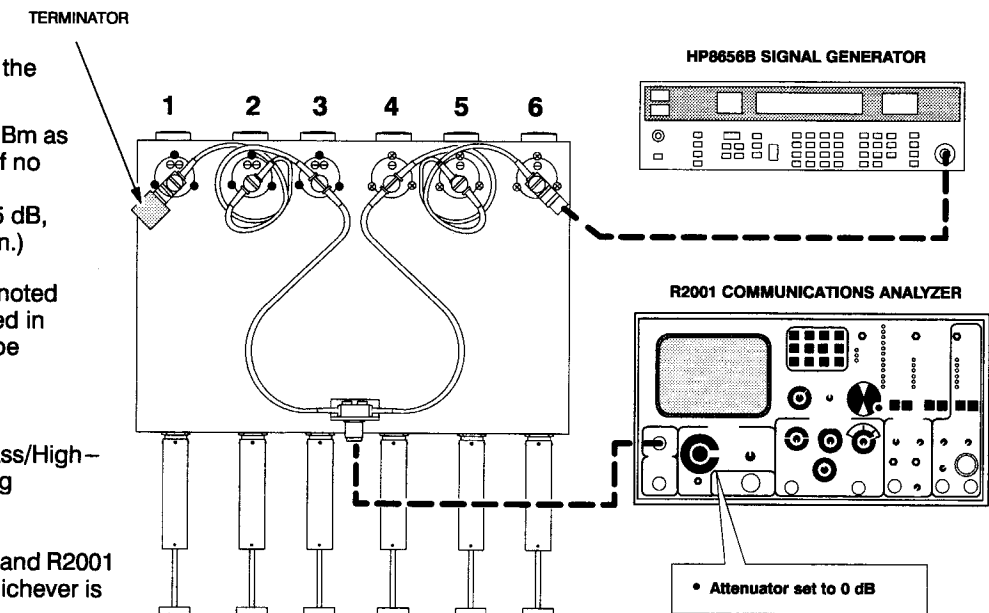
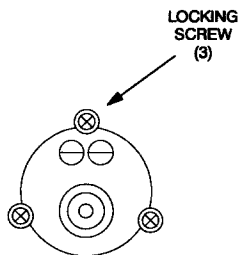

Figure 5. Quantar VHF Duplexer Field Tuning Procedure (Sheet 2 of 3)

7

POST-TUNING CHECKS

- 1 Make sure all locking screws are tight. Re-install dust covers on all trimmer capacitors.



- 2 Make sure all tuning rod locking screws (6) are tight.

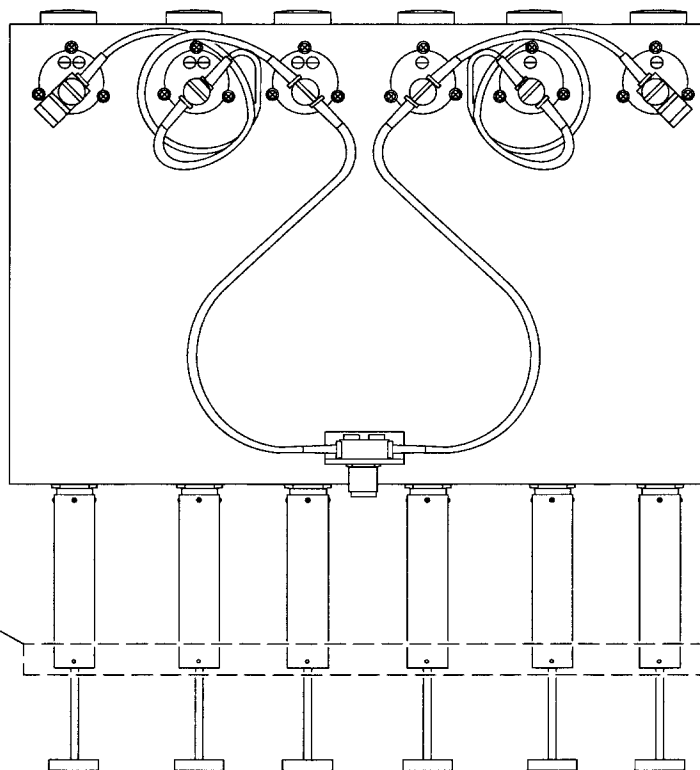

Figure 5. Quantar VHF Duplexer Field Tuning Procedure (Sheet 4 of 4)